

# Development and application of an ultra-miniaturized blood collecting /testing system by MEMS

Sumio NAKAHARA, Seiji AOYAGI, Norio TAGAWA, Yasuhiko ARAI,  
Kiyoshi BANDO, Susumu TAMURA, and Tsutomu TAJIKAWA

(Received October 2, 2006)

## Abstract

This report outlines research, supported by a Kansai University special fund (2004). Collecting blood and sending it to a given destination is inevitable in micro-TAS application for the purpose of this research. Development of a micro-needle made of biodegradable polymer and a method for collecting blood with this micro-needle, evaluation of bloodstream characteristics in a micro-channel, and development of supporting technology for collecting and analyzing blood are discussed in this paper. In each case, successful new technologies were developed.

## 1. Introduction

The blood test is an important inspection good tool for early detection of diseases and maintenance of health. Also, the number of diabetics is increasing in developed countries. Some of them have to collect their own blood for glucose level measurement at least twice a day, which is indispensable for health monitoring. In this blood collection, human skin is punctured by a solid metal lancet needle of straight shape to cause small-scale bleeding, which is both painful and a little frightening. A low-invasive needle is badly needed in many medical treatments. Several micro-needles have been reported for biomedical applications, such as drug delivery, measurement of cortical bio-potentials, etc. On the other hand, a human being has almost no pain or fear when pricked by a mosquito's needle. The diameter of a mosquito needle is about  $30\ \mu\text{m}$ , which is small enough to avoid the pain spots in human skin. Also, the mosquito's needle has a jagged shape, which is said to make effective for easy insertion.

Biodegradable polymer is also investigated. This material is extremely safe, since it is hydrolyzed to  $\text{CO}_2$  gas and  $\text{H}_2\text{O}$  in the human body. We fabricated a jagged-shaped solid needle made of biodegradable polymer (Poly Lactic Acid, PLA) by etching a groove on the surface of a silicon die, molding polymer into this groove, and then releasing it.

Selection and development of the best material and their micro-fabrication methods, estimation of bloodstream characteristics in a micro-channel, and supporting technologies for collecting blood and for analyzing blood by micro-TAS are discussed in this study. For example, a new electrical memory device for a data-analyzing system, a micro 3-D shape measurement method by SEM, a storage device for inspection data, and glass plate micro-fabrication technologies.

## 2. Organization of the project

Seven research groups were incorporated under the schema shown in Fig.1. The project was organized by Sumio Nakahara. The seven groups were constructed for the execution of research into one of the fields below. One researcher from each group played the role shown in Fig.1 in this project. The themes and goals of each group were defined as follows;

- (Group 1): the development of a micro needle for sampling blood using biodegradable materials and MEMS technology (Aoyagi)
- (Group 2): the development of a biodegradable polymer needle having a trench for collecting blood by capillary force (Aoyagi, Tajikawa)
- (Group 3): the evaluation of bloodstream characteristics using MEMS technology (Bando, Tajikawa)
- (Group 4): the development of ferroelectric memory for micro-electronics circuits in an analysis system (Tamura, Nakahara)
- (Group 5): the development of a micro-three dimensional shape measurement method based on shadow moiré using scanning electron microscopes (Arai)
- (Group 6): the fabrication of a diffractive optical element using a direct laser lithography system (Nakahara)
- (Group 7): the development of MEMS-based aberration-free mirror micro-actuators using PZT thin films in optical disk drivers (Tagawa)

An outline and the results of the research each group conducted are shown in the next section. Most research for this project was performed in the clean room of High Technology Center at Kansai University.

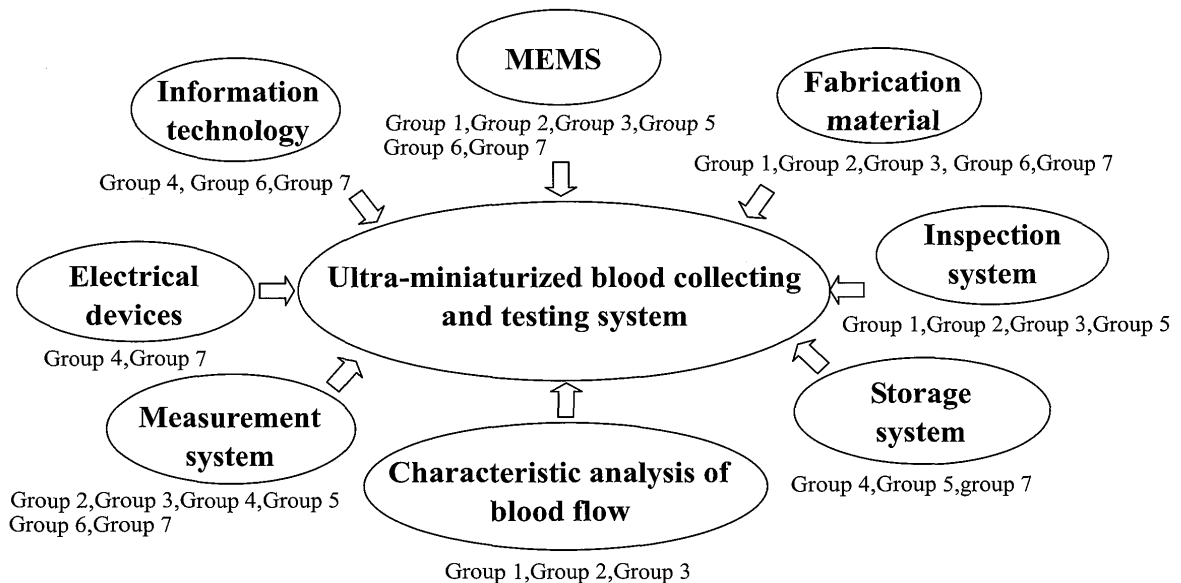

Fig. 1 Input schema and project fields

### 3. Activities and results

#### 3.1 Development of a micro lancet needle made of biodegradable polymer for low invasive medical treatment (Group 1)<sup>1)</sup>

The development of a micro lancet needle made of biodegradable polymer (Poly Lactic Acid, PLA) was addressed by this project group. This device would be applicable to a blood test system for diabetics. The size of the micro lancet needle is as follows: width is  $200\mu\text{m}$ , length is  $1000\mu\text{m}$ , and thickness is  $100\mu\text{m}$ . Since PLA naturally degrades in tissues, this material is safe for the human body. To achieve the purpose of this study, we focused on i) the wet chemical anisotropic etching process of a silicon negative groove, ii) the dry etching process of the same using gray scale mask, and iii) the micro-molding process of PLA. The resistance force during insertion of a needle into an artificial skin of silicone rubber was investigated. Sensory tests of insertion into human skin were also carried out.

SEM images of the fabricated needles are shown in Fig. 2. A high L/D ratio of larger than 8 (see long lancet needle shown in Fig. 3) with almost no burrs was realized.

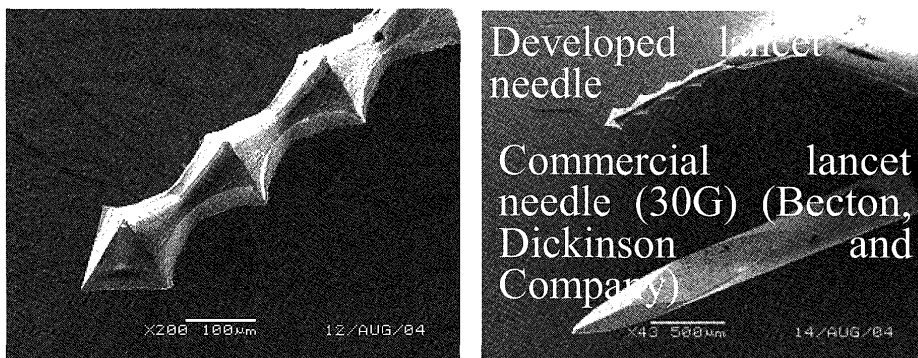
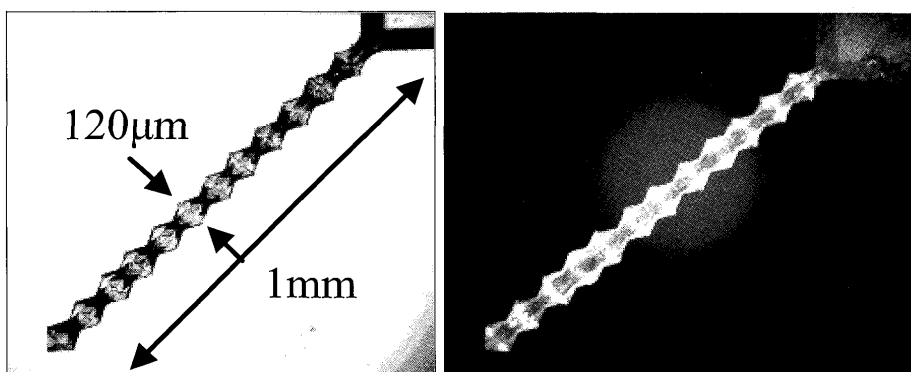

Fig. 2 SEM image of fabricated lancet needle



(a) Groove on Si surface

(b) Fabricated needle

Fig. 3 Optical image of long type lancet needle

### 3.2 Development of a biodegradable polymer needle having a trench for collecting blood by capillary force (Group 2)<sup>2)</sup>

A biodegradable polymer (Poly Lactic Acid, PLA) needle having a trench for collecting blood was developed in this project group. A solid micro needle of polymer can be fabricated by the micro-molding method. However, a hollow needle is difficult to fabricate with this method. It is also difficult to fabricate a long hole with ultra-high aspect ratio along the centerline of a micro-molded needle. On the other hand, it is comparatively easy to fabricate a trench on a needle surface. Blood runs up along this trench by capillary force, which realizes simple and easy blood collection without using a pumping mechanism. A needle with straight shank is fabricated by wet etching of a groove on a silicon die. A trench is fabricated on the top surface of the needle by laser micromachining. The performance of collecting blood with this needle is then experimentally evaluated.

An example of blood collection is shown in Fig. 4. The abdomen of a mosquito, which has already sucked human blood, is penetrated by the fabricated needle as shown in Fig. 5. It was observed that both transparent body fluid and red blood a up along the trench. This result implies the possibility of penetrating human skin, collecting blood, and guiding it to a blood analysis site on a chip in micro-TAS applications.

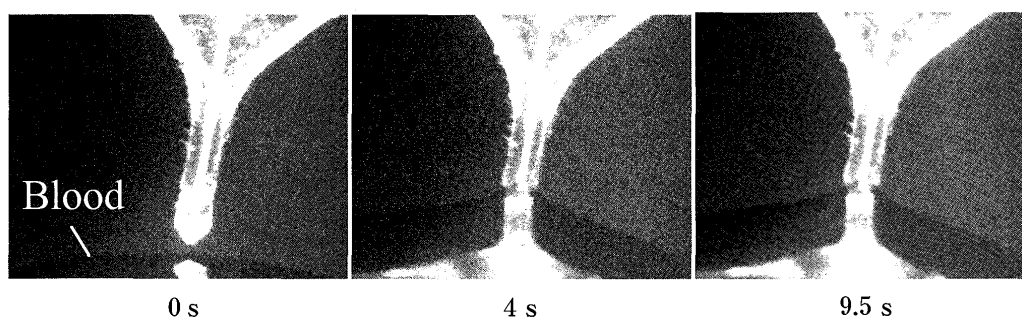

Fig. 4 Example of blood collection

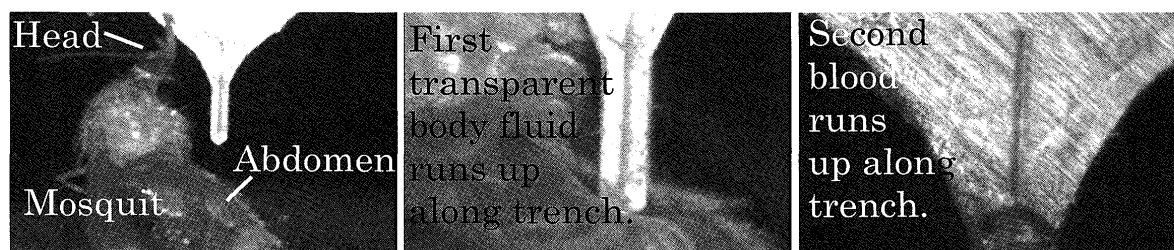

Fig. 5 Collection of blood from mosquito

### 3.3 Evaluation of bloodstream characteristics in a micro-channel (Group 3)<sup>3)</sup>

By using a fabricated micro-channel, the temporal behavior and deformation of RBC could be observed more clearly than by using a conventional micro-channel. The visualization showed that three different kinds of deformation were observed. In the case of axisymmetrical deformation at a similar velocity in physiological flow, it was found that the RBC did not deform through the whole body but only locally in the rear sides of the cells. The RBC was able to pass through a micro-channel of about  $3\ \mu\text{m}$  height and width. Deformability measurements showed that the deformability of RBC had clearly decreased with day lapsed

from blood drawing.

The result showed that some erythrocytes were deformed symmetrically and others asymmetrically in the channels, as shown in Fig. 6, and these differences in shapes were caused by the erythrocyte contacting the channel wall at its entrance. Among the erythrocytes which were deformed symmetrically, some had parachute-like shapes, as can be seen from Fig. 6 (b-2). The difference between Fig. 6 (b-1) and (b-2) seems to be the result of different erythrocyte velocity. The deformation into parachute-like shapes was rarely found when their velocity was less than 0.4mm/s. Fig. 7 is a microscopic visualization image of an erythrocyte which has been deformed into the parachute-like shape. It was found that this type of erythrocyte did not deform through the whole body but only in the rear side of the cells.

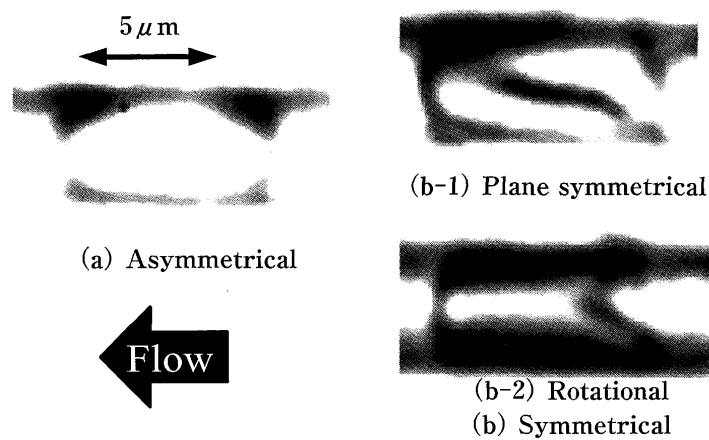

Fig. 6 Three typical deformations of RBC flowing through a micro-channel.

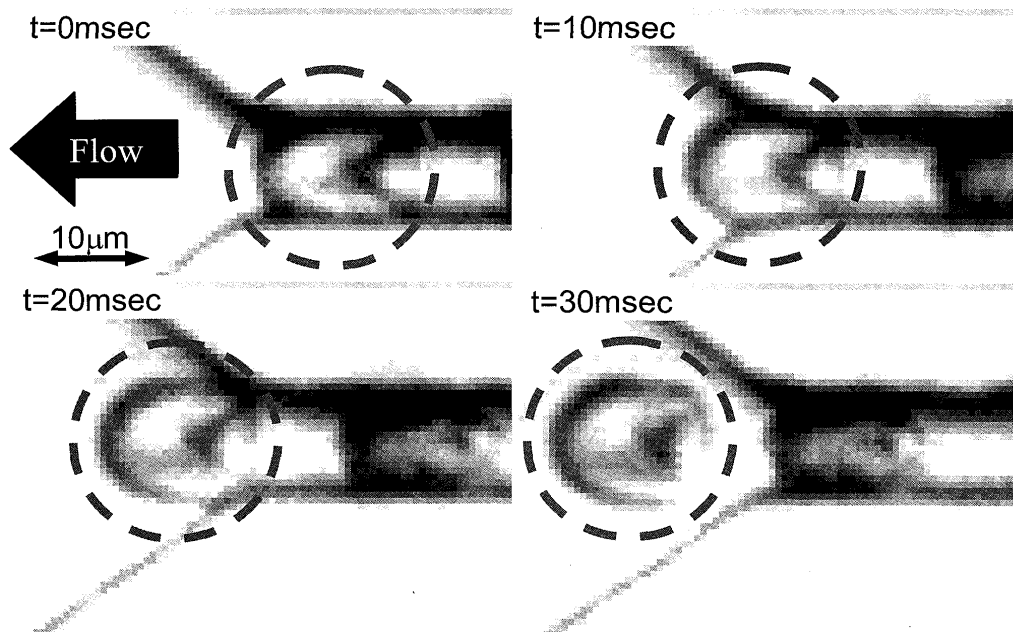

Fig. 7 Visualization of recovering deformation of parachute-shaped RBC at the MC outlet.

### 3.4 Development of ferroelectric memory for micro-electronics circuits in an analysis system. (Group 4)<sup>4)</sup>

The development of memory devices for data processing of analysis in micro-TAS was studied in this project group. Recently ferroelectric memory devices have attracted much attention from the viewpoint of the next generation of non-volatile memory devices. A ferroelectric-gate FET (FeFET) memory can compose one memory a transistor, obeys the scaling rule for high-density implementation and can read out the stored data non-destructively. However, FeFET has not yet been put to practical use.

To fabricate the FeFET memory of the Metal/Ferroelectric/Insulator/Semiconductor (MFIS) structure, ferroelectric materials with a small remanent polarization value and a small relative dielectric constant are preferable. A big remanent polarization value generates a big depolarization field in FeFET memory. Moreover, the gate voltage is divided into the ferroelectric capacitor and the series insulating layer capacitor. To operate at a low voltage, the majority of the gate voltage should be applied to the ferroelectric capacitor. Thus the capacity of the ferroelectric capacitor should be much lower than the capacity of the insulating layer.

We tried to fabricate a new ferroelectric film with a small remanent polarization value and a small relative dielectric constant. We found that the remanent polarization value and the relative dielectric constant of SBT films decreased with the amount of additional Si, as shown in Fig. 8 and 9. Si-added SBT thin film is suitable for use in the FeFET ferroelectric memory.

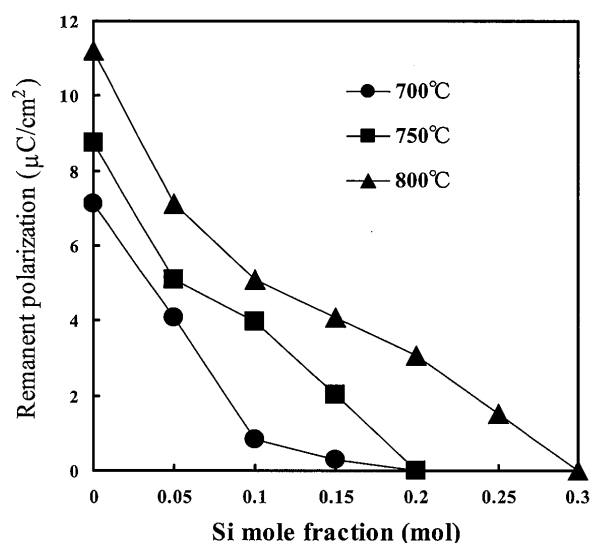

Fig. 8 Dependence of remanent polarization of SBT thin films on amount of added silicon.

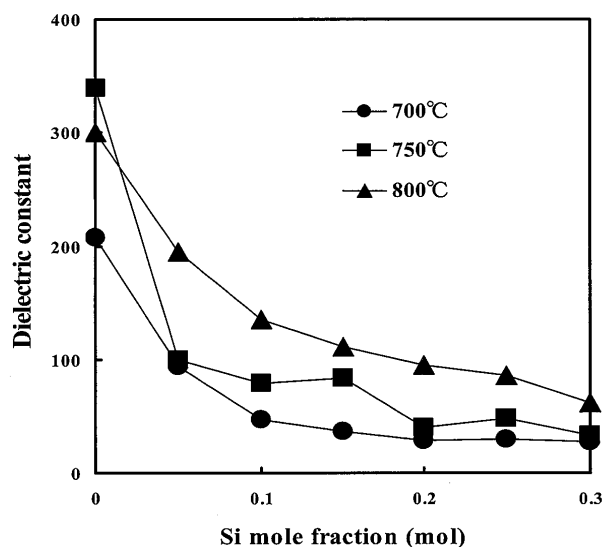

Fig. 9 Dependence of relative dielectric constant of SBT thin films on amount of added silicon.

### 3.5 Micro three dimensional shape measurement method based on shadow moiré using scanning electron microscopes (Group 5)<sup>5)</sup>

A novel precise three-dimensional shape measurement method using SEM and moiré topography was developed in this project group. The possibility of measurement of wavelength order by this method has been discussed using the results of experiments confirming the

principle of this idea. In these experiments, the method with high resolution power based on the new measurement method is proposed by employing fringe scanning technology for the shadow moiré. The optical system is constructed with SEM using backscattering electrons, a grating holder which can shift the position of a grating, and the grating whose pitch is 120 micrometers. Measured results using a bearing ball as a sample show that high resolution measurement around one micrometer can be performed by introducing the fringe scanning method to the new measurement. An error analysis of this method is also performed for improving the measurement accuracy of this method.

In Fig.10, the shadow of the grating on the surface of the ball can be observed clearly. It can be confirmed that the phase of moiré fringes changes with shift of the grating. The profile of the ball surface is shown in Fig.10 and the measurement result is shown in Fig.11. The standard deviation of the difference between them is  $1.21\mu\text{m}$ . From our experimental results, the validity of the proposed measurement method using SEM with backscattering electrons is confirmed.

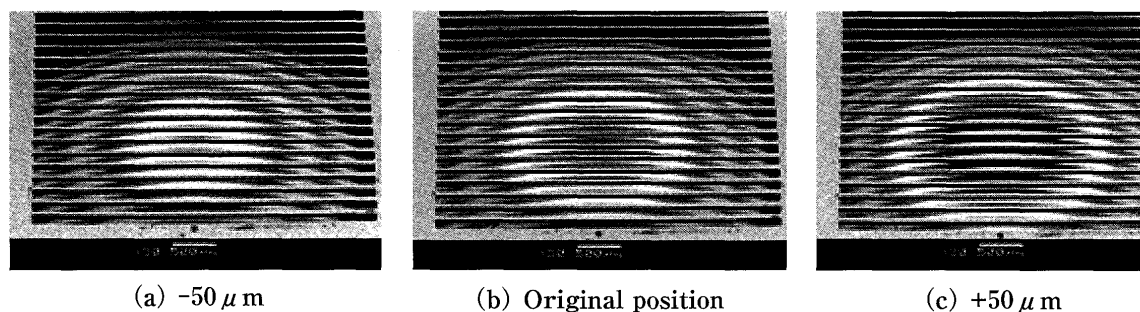

Fig. 10 Fringes by SEM optical system

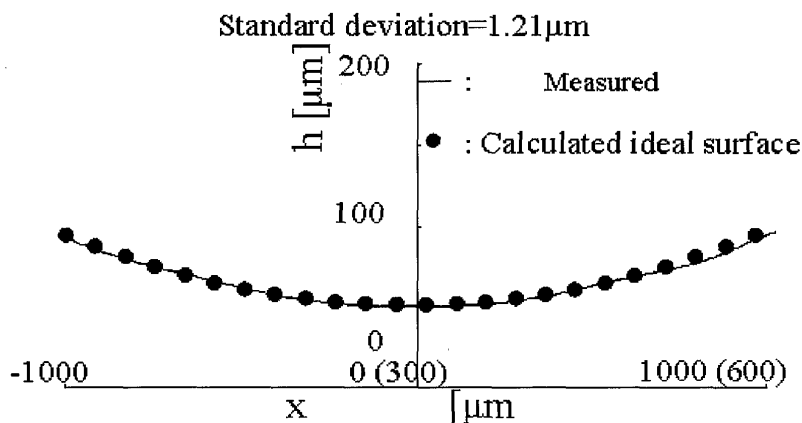

Fig. 11 Measured result

### 3.6 Fabrication of diffractive optical element using a direct laser lithography system. (Group 6)<sup>6)</sup>

In this group, micro-fabrication for glass is studied in order to produce micro-chips of blood inspection. The optical element is produced by micro-fabrication technology, because evaluation of accuracy of fabrication is easy using an optical system. We created the diffractive optical elements with the use of a direct laser lithography system that has a high-resolution

drawing feature, high-speed drawing, and a high accuracy positioning system. Although it is difficult to draw to a large-sized substrate with an electron-beam lithography system, since a direct laser lithography system makes it possible, production of the large diffractive optical elements is expected. Furthermore, 2-level phase-type diffractive optical elements were produced by wet etching processing to the substrate, and comparison of the diffraction efficiency of the amplitude-type diffractive optical element and the phase-type diffractive optical element was discussed.

Wet etching and RIE were used in combination with laser direct write lithography to generate refractive contours in soda-lime and fused-silica glass substrates of mask blanks, respectively.

Firstly, soda-lime glass substrates were etched in a wet process by buffered hydrogen fluoride BHF. Secondly, fused silica glass substrates were etched in a commercial RIE with  $\text{CHF}_3$  gas. Mask patterns were defined by a laser direct writing system. Fig.12 shows SEM photographs of Fresnel Zone Plate (FZP) after RIE Process. Table 1 shows diffraction efficiencies of FZP on different wavelengths and different relief depths.

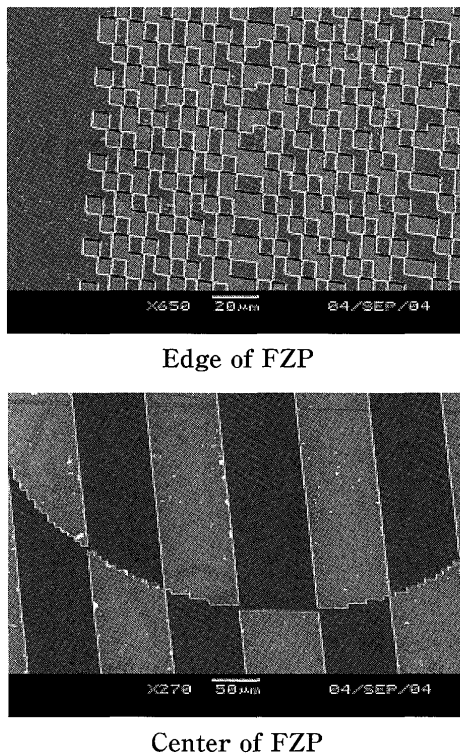

Table 1. Diffraction efficiency of Fresnel zone plate

He-Ne laser $\lambda$ : 633nm	Amplitude- type	Phase-type	
		Relief depth	
		543nm	625nm
Diffraction efficiency	6.0%	23.7%	27.0%

Disc laser $\lambda$ : 532nm	Amplitude- type	Phase-type	
		Relief depth	
		543 nm	625 nm
Diffraction efficiency	5.9%	24.7%	24.0%

Fig. 12 SEM Photographs of FZP after RIE Process

### 3.7 MEMS-based aberration free mirror micro-actuators using PZT thin films in optical disk drivers. (Group 7)<sup>7)</sup>

In this group, ultra-high density data storage devices for inspection information technology were developed. In advanced information technology, a large amount of data must be handled, and it is necessary to develop ultra-high density data storage devices. So far, many innovative technologies have been proposed in order to increase the recording density of optical disk storage devices. The multilayer optical disk is one of these high-density technologies. This



technology, however, has serious technological problems related to aberration arising in multilayered disk media. We propose MEMS-based aberration free mirror micro-actuators using PZT thin film. The fundamental design of the proposed MEMS-based micro-mirror actuator mechanism is studied and the fabrication process of the mirror actuator is developed.

The schematics of the mirror actuator mechanism and its driving principle are shown in Figs 13 and 14. The mechanism consists of Si substrate, mirror face, upper and lower electrodes, and PZT thin films. The mirror should be deformed so as to make the toroidal curve surfaces using PZT thin films. The specifications of applied voltage and displacement of mirror outer edge are  $\pm 30V$ ,  $\pm 2.1 \mu m$ , respectively. FEM simulations were carried out in order to design the optimum mirror configuration. Using this process, the proposed MEMS-based aberration free mirror micro-actuator mechanisms were developed.

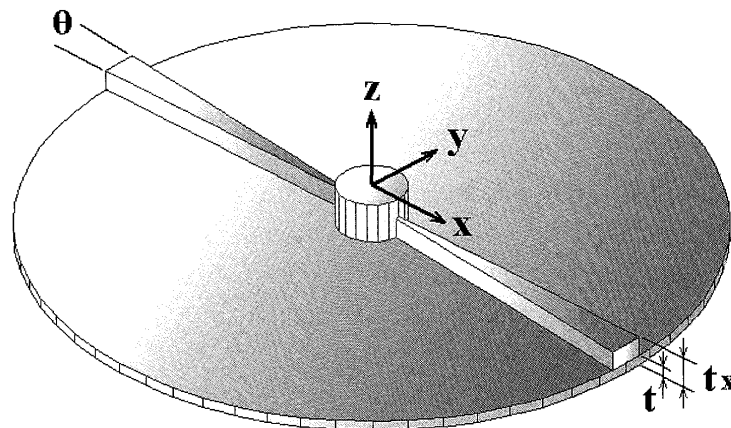

Fig. 13 Schematic of micro actuator

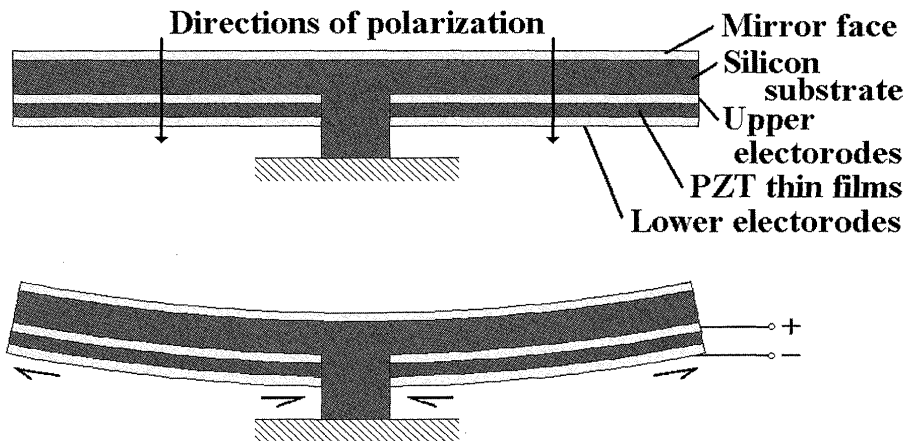

Fig. 14 Driving principle

#### 4. Conclusions

In this paper, a novel ultra-miniaturized blood collecting and testing system for life science using nano-micro-technologies was researched and developed. A micro-lancet needle made of biodegradable polymer was produced. Poly Lactic Acid was examined as the material

of the biodegradable polymer. The characteristics of bloodstream in a micro-channel were also investigated in order to develop a  $\mu$ -TAS. The behavior and dynamic characteristics of deformability of red blood cell in the micro-channel were visualized by using devices made by MEMS. Collecting blood by capillary force was also discussed. The development of new electrical devices and a storage system for data-processing of micro-TAS were also discussed. As shown in the results, the many kinds of micro-fabrications and measurement technologies for producing a micro-TAS were discussed in multi directions of engineering in this project. A lot of successful results were reported for the development of an ultra-miniaturized blood collecting and testing system. The possibility of blood analysis on a chip in micro-TAS applications was confirmed by developing many kinds of novel technologies.

The results of this project have already been reported in 3 international journals, 14 international conferences, 3 domestic journals, and 4 domestic conferences. Important reports of this project are shown in the references section below.

### Acknowledgement

This is a product of research which was financially supported by the Kansai University Special Research Fund 2004, "Development and application of ultra-miniaturized blood collecting / testing system by MEMS" and HRC in Kansai University.

### References

- 1) S. Aoyagi, H. Izumi, T. Aoki, M. Fukuda: Digest of Technical Papers of the 13th International Conference on Solid-State Sensors and Actuators (Transducers '05), 1195-1198 (2005.6).
- 2) S. Aoyagi, H. Izumi, Y. Isono, K. Makihira, M. Fukuda: Technical Digest of the 19th IEEE International Conference on Micro Electro Mechanical Systems (MEMS 2006), 450-453 (2006.1).
- 3) T. Tajikawa, K. Ohba, K. Higuchi, C. Sakakibara: Journal of the Visualization Society of Japan, Vol.25(12), 84-91, (2005.12 in Japanese)
- 4) S. Tamura, Y. Omura and S. Nakahara; Jpn. J. Appl. Phys. 43 (2006) 7871.
- 5) Y. Arai S. Yokozeki: Journal of Modern Optics. (in printing).
- 6) S. Nakahara, J. Nakaichi, T. Kawahara, T. Tsuchitani, H. Tottori, S. HISADA, T. FUJITA: HODIC Circular, Vol.25, No.4 (Nov. 2005) pp.8-11.
- 7) K. Fujita, N. Tagawa, A. Mori, F. Tanaka, S. Maeda and K. Nagashima: Proceedings of Kansai Branch annual meeting, JSME (2006), No.064-1,15-6 (in Japanese)